

PRODUCT NAME : Spoke
ITEM NUMBER: E21028-AL

Please consult your electrician for hanging fixture and wiring.

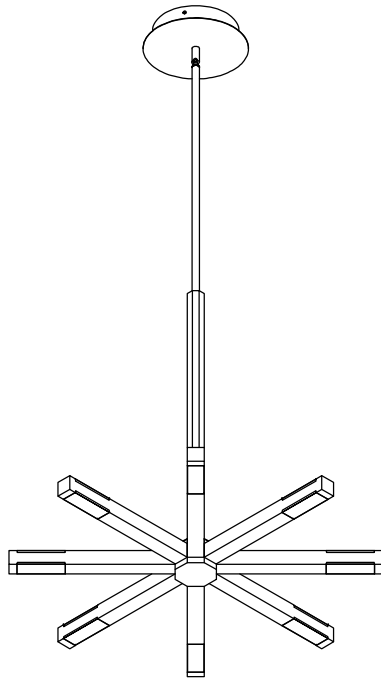

the fixture is designed to dim with a standard Triac forward phase dimmer. Dimming levels will vary by dimmer.
Below is a list of recommended dimmers:
Lutron MACL-153M
Lutron DVL-153P
Lutron SCL-153P
Leviton IPL06-10Z
Leviton 6674-POW

Due to the inrush current wattage should not exceed 150 watts of product for a 600 watt dimmer

WARNING: WIRES NEED TO BE CONNECTED TO DRIVER FOUND IN CANOPY AND SHOULD NOT CONNECT DIRECTLY TO POWER SOURCE OR A SHORT MIGHT OCCUR.

51W LED

MADE IN CHINA

IMPORTANT: Turn off the power at the main fuse or circuit breaker box before starting installation

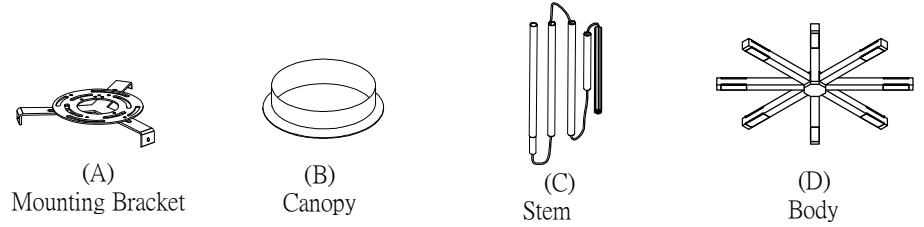

Locate all hardware & components before discarding packaging

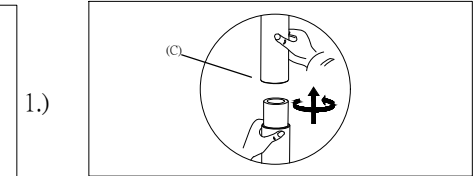
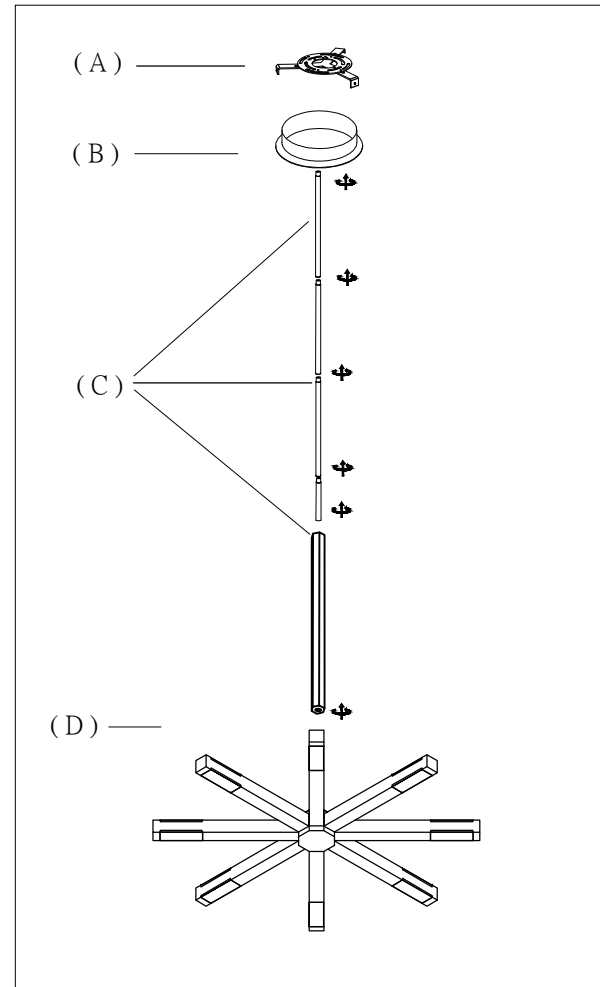

1.)

Step.1: Run wire through the stems (C) and combine stem lengths to desired mounting height.

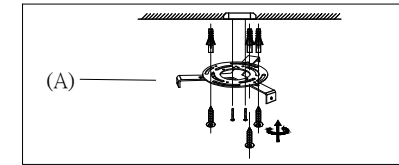

2.)

Step.2: Remove the mounting bracket (A) from canopy and install to electrical box.

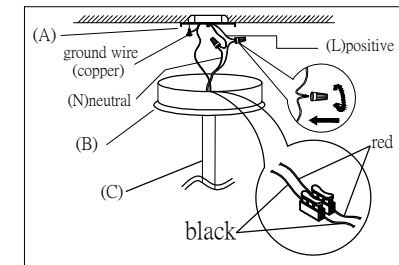

3.)

Step.3: Wire fixture to wires in outlet box. Install green wire to ground screw.

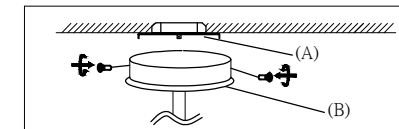

4.)

Step 4: Install canopy (B) to bracket (A) and tighten screws at the ends of canopy to secure.

Cleaning & Care:

Clean with soft cloth and a mild detergent.
Do not use abrasive cleaner.